



REMAK

Redüktör

HELİS DİŞLİLİ REDÜKTÖRLER

RDX

HELIX GEAR GEARBOXES

RDX



REMAK REDÜKTÖR MAKİNA SANAYİ

www.remakreduktor.com.tr



REMAK REDÜKTÖR MAKİNA SANAYİ

HELİS DİŞLİLİ REDÜKTÖRLER

RDX

HELIX GEAR GEARBOXES

RDX

HELİS DİŞLİLİ REDÜKTÖRLER

RDX

Üretimini gerçekleştirdiğimiz RDX tipi redüktörlerimiz, alanında, hissedilen kalite ve dizayn eksikliğini gidermek istenilen devir ve güçlerle üretilmektedir. Redüktör dizayn gereği girişi erkek milli çıkış tahriği delik milli olmasından dolayı birçok uygulama alanı için ayrıca çektirmeli kullanımından dolayı montaj kolaylığı ve işletme esnekliği sağlanmaktadır.

RDX tipi redüktörler özellikle yüksek duruş kalkış torkları olan, eğimli yerlerde ani zorlanmalara maruz kalan ve çok sık yükte durup kalkmaya mukavim sistemlerde kullanılmaktadır.

Çıkış milleri ve Flanşları, standart ürün üzerine sonradan ilave edilebilmektedir.

Bu redüktörlerde tahrik sistemi dıştan kayış kasnak, zincir dişli...vb. elemanlarla yapıldığında ani moment yükselmelerine karşı yapısı gereği gerdirilerek takıldığından yüksek momentleri karşılayabilmektedir.

Yüksek mukavemet ve verimin ön plana çıktığı uygulama alanlarında, sonsuz vidalı redüktörlerin yerini almaktadır. Radyal yükler açısından da büyük avantajlar sağlanmaktadır.

Bu redüktörler istendiğinde ters çalışmaya imkan vermeyecek şekilde kilitli rulman tertibatı ile tek yönde çalışma imkanı sağlanmaktadır. RDX tipi redüktörler çok küçük hacimlerde, çok büyük moment iletme kabiliyetine sahiptirler. RDX tipi redüktörlerin gövdeleri iki eş parçadan oluştuğundan dolayı bakım ve servis kolaylığı sağlanmaktadır. Bu redüktörlerimizde dişlilerdeki aşınmayı önleyici özel dişli yağları kullanılmaktadır.

Yan yüzde oluşturulmuş bağlantı noktalarından ayrıca redüktörlerin çektirme gergi sisteminin dışında yan yüzeylerden şase bağlantı uygulanmasına musaittir.

HELICAL GEAR GEARBOXES

RDX

A new type gearbox has been manufactured and introduced in different powers and cycles requirements.

Desing of the gearbox wich includes, output shaft with hole allows different applyments . Rope fitting system accuses easy installment and easy usage.

Having high starting and stopping torque, RDX gear reducers are suitable to be used in inclined positions where instant loading occured and enables the gearbox running and stopping in excessive load conditions.

The output shaft and flange can be added to the standart hallow shaft gearbox without any change on the gearbox.

Drive system in RDX reducers of V-Belt, Belt Pulley, Gear ect... As the mounting carried out by belt-tensioner, the high torque occured can easily be met.

In applications where efficiency and strength is most important hollow shaft gearboxes are preferred to worm gearboxes. Hallow shaft gearboxes have also advantages in overhung loads. On request the gearbox is available with anti-runback device enabling the output shaft rotation in one direction.

RDX reducers have high torque transmission capacity in small sizes.

Easy maintenance and service due to the double gear housing.

Special lubrication oil is used in order to prevent abrasion.

With the connection points on the lateral sides, gearboxes allows to be wanted by rape fitting systems applments.

TİP TANIMLAMASI / UNIT DESIGNATION

XXX - X - X - X - XX - XXX

Motor Büyüklüğü / Motor Size

90M

Gövde uzunluğu / Framen Lenght
Motor Büyüklüğü / Motor Size

Redüksiyon Oranı /

1/10,.....1/30

Giriş Tipi / Input Type

M :Motorlu / With motor

T :Motorsuz / Without

Çıkış Milli Özelliği / Output Shaft

1/F :Delik Milli Çıkışlı - Hollow shaft output/
Flanş Çıkışlı - Flange Output

2/F :Dolu Mil Çıkışlı - Solid shaft output/
Flanş Çıkışlı - Flange Output

Gövde Büyüklüğü / Housing Size

1 8

Redüktör Tipi / Gearbox Type

RDX Serisi / RDX Serie

RDX - M - 1	Delik milli tip helisel redüktör - motor bağlantılı - delik milli çıkış Hollow shaft helical gearbox - Direct motor coupled - Hallow shaft output
RDX - M - 2	Delik milli tip helisel redüktör - motor bağlantılı - dolu milli Hollow shaft helical gearbox - Direct motor coupled - solid output shaft
RDX - M - F - 2	Delik milli tip helisel redüktör - motor bağlantılı - delik milli ve flanş çıkışlı Hollow shaft helical gearbox - Direct motor coupled - Hollow output shaft and flange output
RDX - M - F - 2	Delik milli tip helisel redüktör - motor bağlantılı - dolu milli ve flanş çıkışlı Hollow shaft helical gearbox - Direct motor coupled - solid output shaft and flange output
RDX - T - 1	Delik milli tip helisel redüktör - motorsuz ve mil girişli - delik milli giriş Hollow shaft helical gearbox - Solid shaft input without motor - Hollow output shaft
RDX - T - 2	Delik milli tip helisel redüktör - motorsuz ve mil girişli - dolu milli çıkışlı Hollow shaft helical gearbox - Solid shaft input without motor - solid output shaft
RDX - T - F - 1	Delik milli tip helisel redüktör - motorsuz ve mil girişli - delik milli ve flanş çıkışlı Hollow shaft helical gearbox - Solid shaft input without motor - Hollow output shaft and output flange
RDX - T - F - 2	Delik milli tip helisel redüktör - motorsuz ve mil girişli - dolu milli ve flanş çıkışlı Hollow shaft helical gearbox - Solid shaft input without motor - solid output shaft and flange output

Tip Tanımlaması

RDX-M-1

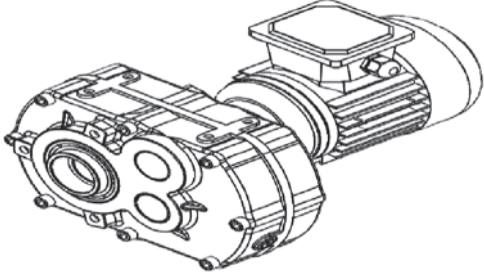

RDX..... REDÜKTÖR TİPİ
M..... MOTOR MAĞLANTILI
1..... DELİK MİLİ ÇIKIŞI
1-8..... GÖVDE BÜYÜKLÜĞÜ
132M..... MOTOR BÜYÜKLÜĞÜ

Unit Designation

RDX-M-1

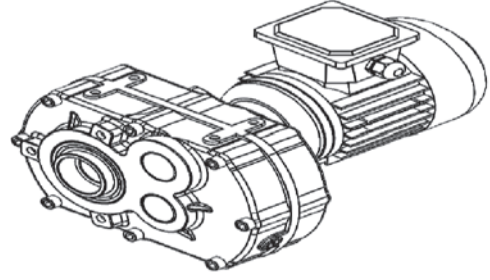

RDX..... GEARBOX TYPE
M..... WITH MOTOR
1..... HOLLOW SHAFT OUTPUT
1-8..... HOUSING SIZE
132M..... MOTOR SIZE

RDX-M-2

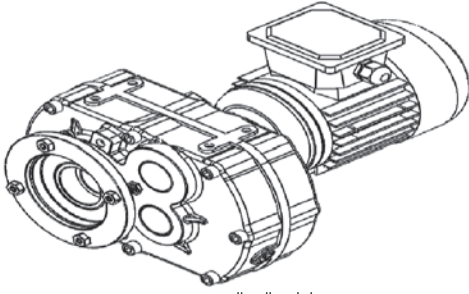

RDX..... REDÜKTÖR TİPİ
M..... MOTOR MAĞLANTILI
1..... FLANŞLI VE DELİK MİLİ ÇIKIŞI
1-8..... GÖVDE BÜYÜKLÜĞÜ
132M..... MOTOR BÜYÜKLÜĞÜ

RDX-M-2

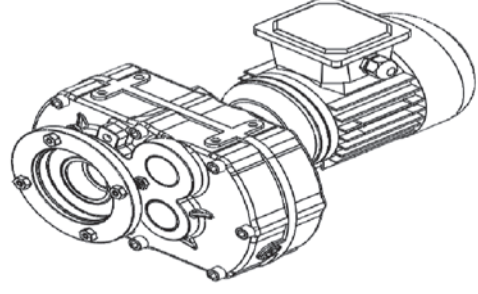

RDX..... GEARBOX TYPE
M..... WITH MOTOR
2..... FLANGE AND HOLLOW SHAFT OUTPUT
1-8..... HOUSING SIZE
132M..... MOTOR SIZE

RDX-Z-1

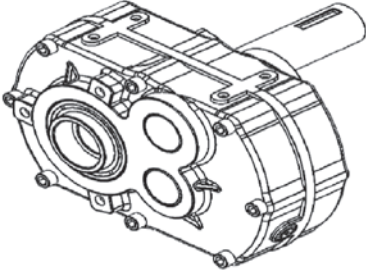

RDX..... REDÜKTÖR TİPİ
M..... MOTORSUZ
1..... DELİK MİLİ ÇIKIŞI
1-8..... GÖVDE BÜYÜKLÜĞÜ
132M..... MOTOR BÜYÜKLÜĞÜ

RDX-Z-1

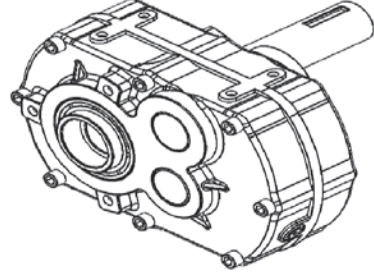

RDX..... GEARBOX TYPE
M..... WITHOUT MOTOR
2..... HOLLOW SHAFT OUTPUT
1-8..... HOUSING SIZE
132M..... MOTOR SIZE

RDX-Z-2

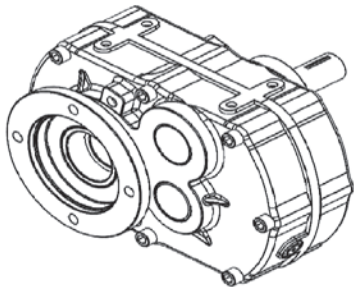

RDX..... REDÜKTÖR TİPİ
M..... MOTORSUZ
1..... FLANŞLI VE DELİK MİLİ ÇIKIŞI
1-8..... GÖVDE BÜYÜKLÜĞÜ
132M..... MOTOR BÜYÜKLÜĞÜ

RDX-Z-2

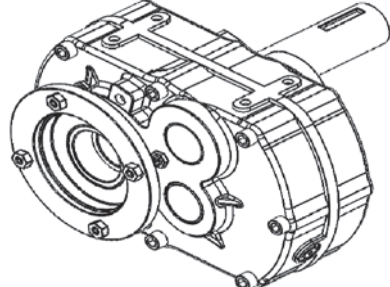

RDX..... GEARBOX TYPE
M..... WITHOUT MOTOR
2..... FLANGE AND HOLLOW SHAFT OUTPUT
1-8..... HOUSING SIZE
132M..... MOTOR SIZE

YAĞLAMA ÖZELLİKLERİ

Yağın seçiminde devir, çevre sıcaklığı, redüktör yağ sıcaklığı, çalışma koşulları ve yağ ömrü önem taşımaktadır. RDX redüktörleri yağı doldurulmuş olarak sevk edilmektedir.

Mineral yağlar her 10.000 çalışma saatinde, sentetik yağlar ise her 20.000 çalışma saatinde değiştirilmelidir. Ağır çevre koşullarında yağ değiştirme periyotlarının kısaltılması tavsiye edilir.

Mineral yağlar ile sentetik yağlar birbirine karıştırılmamalıdır.

LUBRICATING PROPERTIES

In selection of oil it is important to consider speed, ambient temperature, gearbox oil temperature, working conditions and the life required from the lubricant. All units are filled with lubricant before shipping.

The mineral lubricant should be changed after every 10.000 service hours and the synthetic lubricant should be changed after every 20.000 working hours. If the operation conditions are very heavy shorter intervals between changes are recommended.

Mineral oils and synthetic oils must not be confused.

YAĞ ÇEŞİTLERİ TYPE OF LUBRICANT

Yağ Cinsi Type of Lubricant	Çevre Isısı (°C) Ambient temperatures(°C)	ISO Vizkozite Sınıfı ISO Viscosity Grade	BP	ESSO	MOBİL	SHELL
Mineral Yağlar Mineral oil	0 +50	ISO VG 680	Energol GR-XP-680	Spartan EP 680	Mobil Gear 680	Omala Oel 680
	-5 +45	ISO VG 460	Energol GR-XP-460	Spartan EP 460	Mobil Gear 460	Omala Oel 460
	-10 +40	ISO VG 320	Energol GR-XP-320	Spartan EP 320	Mobil Gear 320	Omala Oel 320
	-15 +30	ISO VG 220	Energol GR-XP-220	Spartan EP 220	Mobil Gear 220	Omala Oel 220
	-25 +25	ISO VG 150	Energol GR-XP-150	Spartan EP 150	Mobil Gear 150	Omala Oel 150
Sentetik Yağlar Synthetic Oil	-10 +60	ISO VG 680	-	-	Glygoyle 680	Tivela S 680
	-20 +50	ISO VG 460	Energol SG-XP-220	-	Glygoyle 460	Tivela S 460
	-25 +40	ISO VG 320	-	-	Glygoyle 320	Tivela S 320
	-30 +30	ISO VG 220	Energol SG-XP-220	-	-	Tivela S 220
	-35 +20	ISO VG 150	-	-	-	Tivela S 150
Gresler Grease	-30 +100	-	Energreaser LS 3	Beacon 3	Mobilux 3	Alvania RL 3

* -30 C ile +60 C'yi geçen ısılarda özel keçe kullanınız.

With ambient temperatures bellow -30 C and above approx +60 C shaft sealing rings of a special material quality must be used.

RDX TİPİ REDÜKTÖR YAĞLAMA TABLOSU

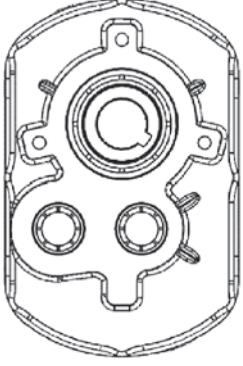

POZİSYON
A

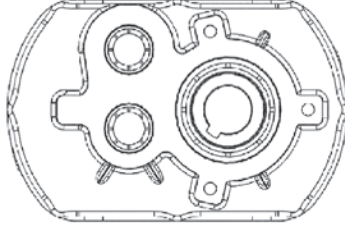

POZİSYON
B

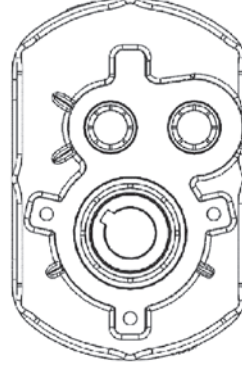

POZİSYON
C

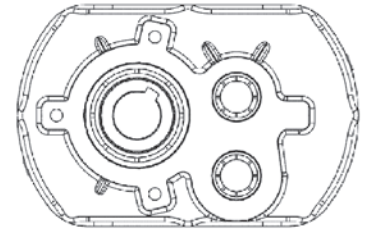

POZİSYON
D

	A	B	C	D
RDX 1	0.6 LT	0.8 LT	0.6 LT	0.8 LT
RDX 2	0.8 LT	1 LT	0.8 LT	1 LT
RDX 3	1.3 LT	1.5 LT	1.3 LT	1.5 LT
RDX 4	2 LT	2.2 LT	2.2 LT	2.2 LT
RDX 5	2.7 LT	3 LT	3 LT	3 LT
RDX 6	3.5 LT	4 LT	3.5 LT	4 LT
RDX 7	5.5 LT	6 LT	5.5 LT	6 LT
RDX 8	6.5 LT	7.5 LT	6.5 LT	7.5 LT

KULLANIM ALANLARI

HELEZONLU VE BANTLI TAŞIYICI UYGULAMASI HELICOID AND CONVEYOR BELT APPLICATION

- RDX serisinin verdiği bağlama kolaylığı ile madencilik, çimento, gübre, granit sistemlerin taşınmasında, helezonlu mikser sistemlerin karıştırılma işlemlerinde susuzlandırma havuzlarında kullanılmaktadır.
- Because of the flexibility of the RDX Series, this application mostly used by mining industry, cement systems, mobilization of granule, helicoid mixer system and drying systems.

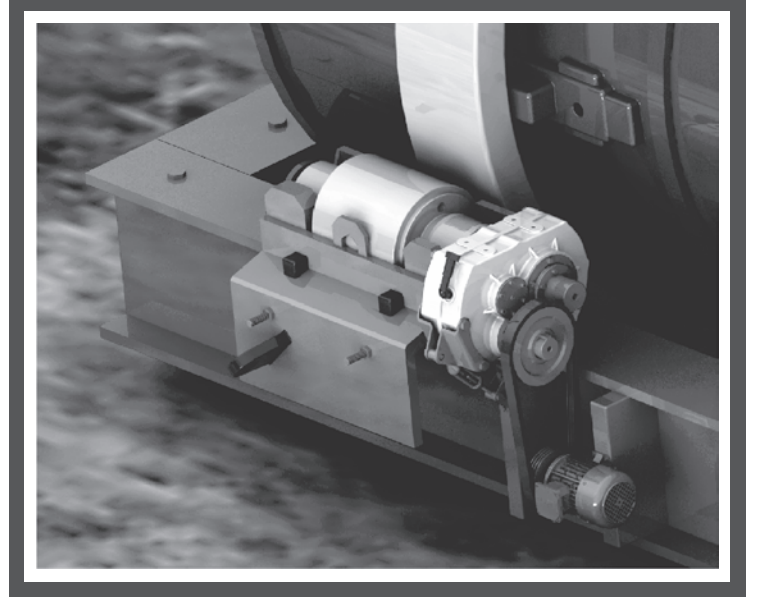

BİLYALI DEĞİRMEN YATAY MİKSER UYGULAMASI BALL ROLLER MILL HORIZONTAL MIXER APPLICATION

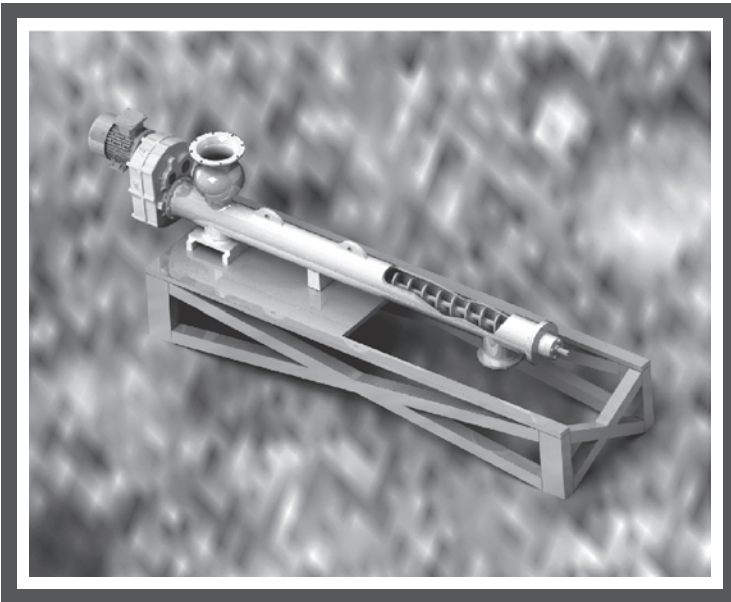

- Madencilik Sektörü, gübre kurutma, değirmencilik ve ayrıca dericilik sektöründe fazlasıyla kullanılmaktadır. Sistemin farklı bir özelliği ise yüksek duruş kalkış torklarına ve ani otoblokajlara dayanımı yüksektir. Ayrıca esnek bağlama olasılıkları ile sistem maliyetini minimuma indirmektedir.
- This application is mostly used by the mining sector, muck drying, milling, in mill systems and leather industry. One of the systems advance is being durable for big powers of stopping and mobilization. Also installation flexibility causes to cost of the system.

KULLANIM ALANLARI

YATAY MİLLİ KARIŞTIRMA VE TAŞIMA UYGULAMASI

HORIZONTAL MILLING MIXER AND TRANSPORTATION APPLICATION

- Özellikle yatay milli mikserler, yem karma, bantlı konveyör taşıma, elevatörler, uzun metraj helezonlar taşıma ve karıştırma sektöründe başarı ile kullanılır.

- This application is mostly used by. Horizontal mixers, animal feed mixers, band conveyor transportation, elevators, long type helecoids, transportation and mixing industries with succes.

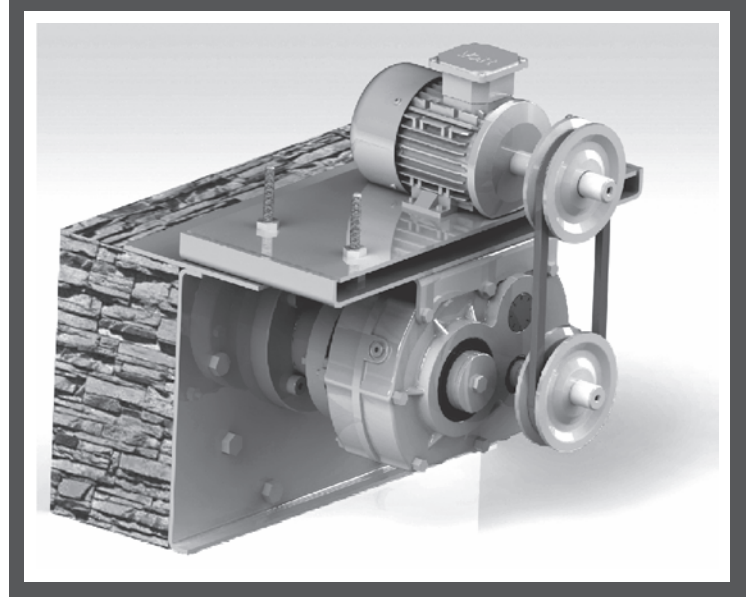

DİK MİLLİ UYGULAMALAR VE DIŞTAN TAHRİK

VERTICAL ROD AND OUTSIDE DRIVING APPLICATION

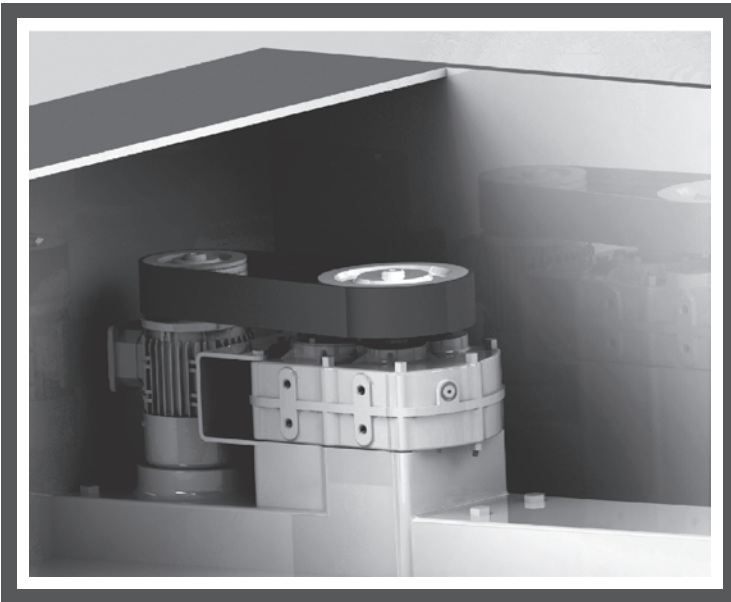

- Bu uygulama ile büyük tonajlarda dik milli kazanların karıştırma mikserlerinde, ayrıca dışarıdan tahrik edilen döndürme ve yürüyüş sistemlerinde, madencilik, arıtmacılık, kimya endüstrisi, tarım makinaları gibi alanlarda yüksek duruş ve kalkış torklarına dayanımı fazladır.

- With this application, it is easy to use in big tonnage weights, vertical rod boilers, outside drived transportation and rotator systems, mining sector, purification pools, chemistry industry and agriculture machines with high capability of stopping and take off powers.

KULLANIM ALANLARI

HİDROMOTOR VE KASNAKLI TAHRİK UYGULAMASI HYDROMOTOR AND PULLEY DRIVER APPLICATION

RDX Serisinin bağlama esnekliği ve aksesuarları ile hidromotor uygulamalarında, taşıma - karıştırma sistemlerinde, torku gerdirme, yüksek mukavemet gerektiren uygulamalarda kullanılır.

With the flexibility and the accessories of RDX Series, it can be used with the hydromotors in such a systems that, transportation and mixing with high torques of power.

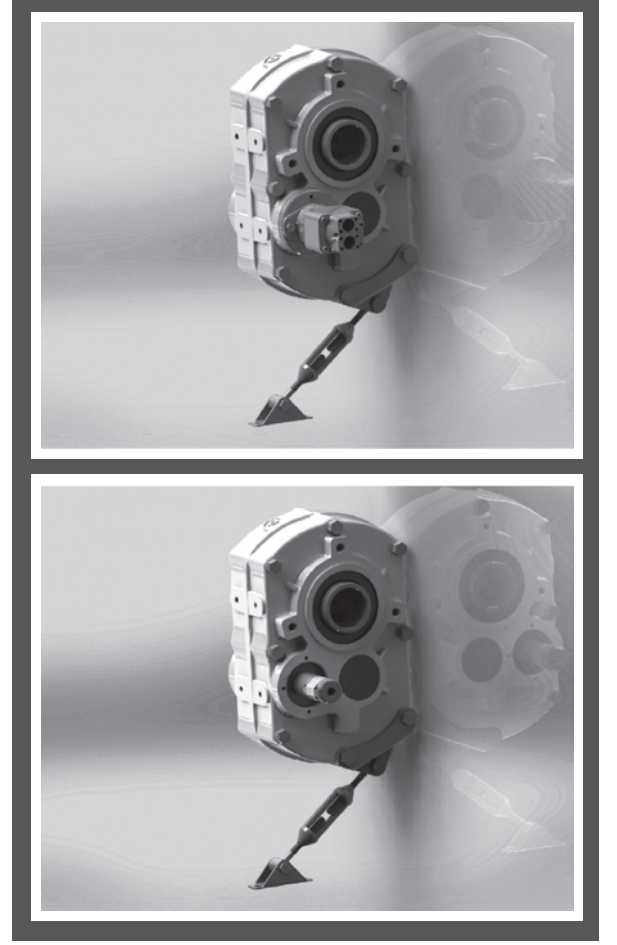

NEDEN RDX SERİSİ ? WHY CHOOSE RDX SERIES ?

- Yüksek Torklara Dayanım
- Esnek Bağlama Kolaylığı
- Birçok Aksesuar ile Birçok Sisteme Dahil Olma
- Kullanım Kolaylığı is Sistem Maliyeti Düşürme
- Helisel Dişliler ile Yüksek Verim Sağlama ve Güç Kaybını Minimuma İndirgeme
- Capability to Stand High Torques of Power
- Flexibility in mounting with lot of positions
- With many accessories, high adaptation to any system
- Lowering the cost of the system with easy usage
- High efficiency with helical gears and leading to minimum loss of power

RDX İÇ DONANIM ve SİSTEM

RDX FEATURES and SYSTEM

1. Yüksek Kalite Dişli Precision High Quality Gearing

- * Bilgisayar ortamında özel hesaplanmış teknik helisel dişliler.
Computer Designed Helical Gears
- * Dişli başına %98.5 verimlilik
98.5% Efficiency Per Gear Stage
- * Ağır yükler için özel alaşım ile üretim
Strong Alloy Materials for High Load Capacity

2. Maksimum Muhafaza Kapasitesi Dizaynı Maximum Capacity Housing Design

- * Şok ve titreşim emen tasarım
Excellent Vibration Dampening & Shock Resistance Features
- * Paslanma ve korozyon karşıtı alaşım
High Corrosion Resistance
- * Güçlü ve yüksek yataklama kapasitesi
Rigid Bearing Support and Positive Gear Alignment

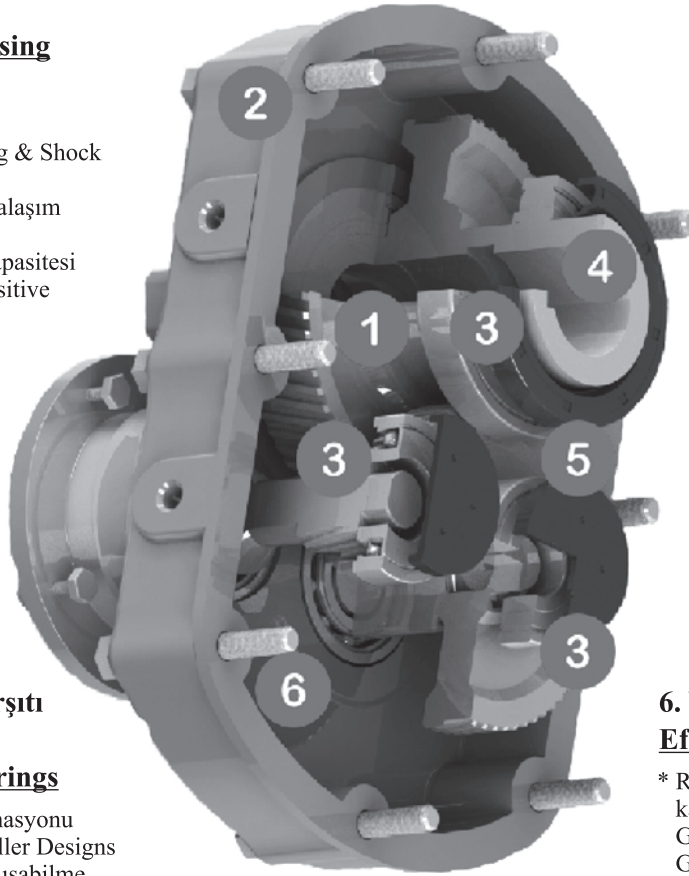

5. Sızdırmazlık ve Geçirmezlik Onaylı Proven Seals Keep Oil In and Contaminants Out

- * Teslimat öncesi %100 fabrika sızdırmazlık testi
%100 Factory-tested Before Shipment
- * Maksimum ömür için pürüzsüz işlenmiş yataklama
Smooth Ground Shaft Surfaces for Maximum Life
- * -30° ile 107°C arası operasyon özelliği
Broad Operating Range of -30° to 107°C

3. Güvenilir Sürtünme Karşıtı Yataklama

Reliable Anti-Friction Bearings

- * Bilyalı ve yataklı rulman kombinasyonu
Combination Ball & Tapered Roller Designs
- * Yüksek kuvvetlerde sorunsuz çalışabilme kabiliyeti
High Thrust Capacity Screw Conveyor Drive Bearings
- * Optimum güç aktarımı için doğru merkezleme
Straddle Mounted Gears for Optimum Support

6. Verimli Yağlama Sistemi Efficient Splash Lubrication System

- * Rulmanlar ve dişliler için yüksek yağlama kapasitesi
Generous Oil Sump for Lubricating All Gears & Bearings
- * Standart dişli yağları ile uyumlu çalışma
Standart Gear Petroleum Lubricants are Suitable
- * Esnek bağlama pozisyonları için birden çok yağlama noktası
Multiple Oil Plugs for Total Mounting Flexibility

4. Maksimum Destekleme için Güçlü Miller Strong Shafts for Support

- * Özel işlemler ile sertleştirilmiş shaftlar
Precision-Machined & Hardened for Maximum Load
- * Açısal yük için kullanılan özel alaşım
High Alloy Steel for Maximum Torsional Loads
- * Şok emici en uygun ölçüler
Generous Size Shaft Keys for Shock Loading

REDÜKTÖR GÜÇ ve SEÇİM TABLOSU
CHARACTERISTICS of RDX SERIES GEARBOX

AĞIRLIK
14
KG

$n_1 = 900 \text{ rpm}$

RDX 1

$n_1 = 1400 \text{ rpm}$

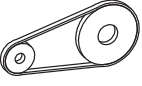
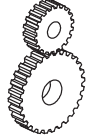
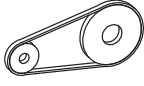
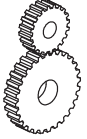
		ÇIKIŞ DEVRİ N2 (rpm)	GÜÇ HP			ÇIKIŞ DEVRİ N2 (rpm)	GÜÇ HP
i	RATIO : i			i	RATIO : i		
1:1	10	90	5,5	1:1	10	140	7,5
	15	60	4		15	93	5,5
	20	45	3		20	70	4
	25	36	3		25	56	4
	30	30	2		30	47	3
1:1,5	10	60	4	1:1,5	10	93	5,5
	15	40	3		15	62	4
	20	30	2		20	47	3
	25	24	2		25	37	3
	30	20	1,5		30	31	2
1:2	10	45	3	1:2	10	70	4
	15	30	2		15	47	3
	20	23	1,5		20	35	2
	25	18	1,5		25	28	2
	30	15	1		30	24	1,5
1:2,5	10	36	3	1:2,5	10	56	3
	15	24	2		15	37	3
	20	18	1,5		20	28	2
	25	14	1,5		25	22	2
	30	12	1		30	19	1,5
1:3	10	30	2	1:3	10	47	3
	15	20	1,5		15	31	2
	20	15	1,5		20	23	1,5
	25	12	1		25	19	1,5
	30	10	1		30	16	1

REDÜKTÖR GÜÇ ve SEÇİM TABLOSU
CHARACTERISTICS of RDX SERIES GEARBOX

AĞIRLIK
17
KG

$n_1 = 900 \text{ rpm}$

RDX 2

$n_1 = 1400 \text{ rpm}$

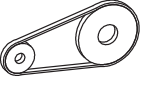
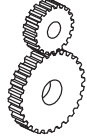
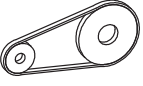
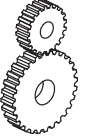
		ÇIKIŞ DEVRİ N2 (rpm)	GÜÇ HP			ÇIKIŞ DEVRİ N2 (rpm)	GÜÇ HP
i	RATIO : i			i	RATIO : i		
1:1	10	90	10	1:1	10	140	15
	15	60	7,5		15	93	10
	20	45	5,5		20	70	7,5
	25	36	5,5		25	56	7,5
	30	30	4		30	47	5,5
1:1,5	10	60	7,5	1:1,5	10	93	10
	15	40	5,5		15	62	7,5
	20	30	4		20	47	5,5
	25	24	4		25	37	5,5
	30	20	3		30	31	4
1:2	10	45	5,5	1:2	10	70	7,5
	15	30	4		15	47	5,5
	20	23	3		20	35	4
	25	18	3		25	28	4
	30	15	2		30	24	3
1:2,5	10	36	4	1:2,5	10	56	7,5
	15	24	3		15	37	4
	20	18	3		20	28	3
	25	14	2		25	22	3
	30	12	2		30	19	2
1:3	10	30	4	1:3	10	47	5,5
	15	20	3		15	31	4
	20	15	2		20	23	3
	25	12	2		25	19	3
	30	10	1,5		30	16	2

REDÜKTÖR GÜÇ ve SEÇİM TABLOSU
CHARACTERISTICS of RDX SERIES GEARBOX

AĞIRLIK
30
KG

$n_1 = 900 \text{ rpm}$

RDX 3

$n_1 = 1400 \text{ rpm}$

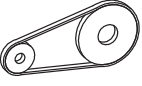
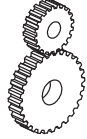
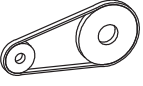
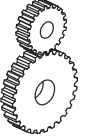
		ÇIKIŞ DEVRİ N2 (rpm)	GÜÇ HP			ÇIKIŞ DEVRİ N2 (rpm)	GÜÇ HP
i	RATIO : i			i	RATIO : i		
1:1	10	90	15	1:1	10	140	20
	15	60	15		15	93	20
	20	45	10		20	70	15
	25	36	10		25	56	10
	30	30	7,5		30	47	7,5
1:1,5	10	60	10	1:1,5	10	93	15
	15	40	10		15	62	15
	20	30	7,5		20	47	10
	25	24	7,5		25	37	7,5
	30	20	5,5		30	31	5,5
1:2	10	45	7,5	1:2	10	70	10
	15	30	7,5		15	47	10
	20	23	5,5		20	35	7,5
	25	18	5,5		25	28	5,5
	30	15	4		30	24	4
1:2,5	10	36	7,5	1:2,5	10	56	10
	15	24	7,5		15	37	10
	20	18	4		20	28	7,5
	25	14	4		25	22	4
	30	12	3		30	19	3
1:3	10	30	5,5	1:3	10	47	7,5
	15	20	5,5		15	31	7,5
	20	15	4		20	23	5,5
	25	12	4		25	19	4
	30	10	3		30	16	3

REDÜKTÖR GÜÇ ve SEÇİM TABLOSU
CHARACTERISTICS of RDX SERIES GEARBOX

AĞIRLIK
45
KG

$n_1 = 900 \text{ rpm}$

RDX 4

$n_1 = 1400 \text{ rpm}$

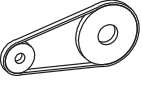
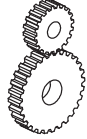
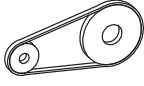
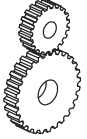
		ÇIKIŞ DEVRİ N2 (rpm)	GÜÇ HP			ÇIKIŞ DEVRİ N2 (rpm)	GÜÇ HP
i	RATIO : i			i	RATIO : i		
1:1	10	90	25	1:1	10	140	30
	15	60	20		15	93	25
	20	45	15		20	70	20
	25	36	10		25	56	15
	30	30	10		30	47	15
1:1,5	10	60	20	1:1,5	10	93	20
	15	40	15		15	62	20
	20	30	10		20	47	15
	25	24	7,5		25	37	10
	30	20	7,5		30	31	10
1:2	10	45	15	1:2	10	70	15
	15	30	10		15	47	15
	20	23	7,5		20	35	10
	25	18	5,5		25	28	7,5
	30	15	5,5		30	24	7,5
1:2,5	10	36	10	1:2,5	10	56	15
	15	24	10		15	37	10
	20	18	7,5		20	28	10
	25	14	4		25	22	7,5
	30	12	4		30	19	7,5
1:3	10	30	10	1:3	10	47	10
	15	20	7,5		15	31	10
	20	15	5,5		20	23	7,5
	25	12	4		25	19	5,5
	30	10	4		30	16	5,5

REDÜKTÖR GÜÇ ve SEÇİM TABLOSU
CHARACTERISTICS of RDX SERIES GEARBOX

AĞIRLIK
69
KG

$n_1 = 900 \text{ rpm}$

RDX 5

$n_1 = 1400 \text{ rpm}$

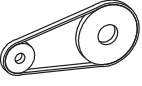
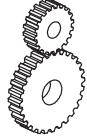
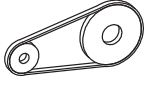
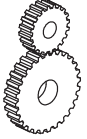
		ÇIKIŞ DEVRİ N2 (rpm)	GÜÇ HP			ÇIKIŞ DEVRİ N2 (rpm)	GÜÇ HP
i	RATIO : i			i	RATIO : i		
1:1	10	90	40	1:1	10	140	50
	15	60	30		15	93	40
	20	45	25		20	70	30
	25	36	20		25	56	25
	30	30	15		30	47	20
1:1,5	10	60	30	1:1,5	10	93	40
	15	40	20		15	62	30
	20	30	20		20	47	20
	25	24	15		25	37	20
	30	20	10		30	31	15
1:2	10	45	20	1:2	10	70	25
	15	30	15		15	47	20
	20	23	15		20	35	15
	25	18	10		25	28	15
	30	15	7,5		30	24	10
1:2,5	10	36	20	1:2,5	10	56	20
	15	24	15		15	37	20
	20	18	10		20	28	15
	25	14	10		25	22	10
	30	12	7,5		30	19	10
1:3	10	30	15	1:3	10	47	20
	15	20	10		15	31	15
	20	15	10		20	23	10
	25	12	7,5		25	19	10
	30	10	5,5		30	16	7,5

REDÜKTÖR GÜÇ ve SEÇİM TABLOSU
CHARACTERISTICS of RDX SERIES GEARBOX

AĞIRLIK
95
KG

$n_1 = 900 \text{ rpm}$

RDX 6

$n_1 = 1400 \text{ rpm}$

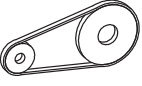
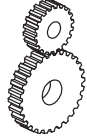
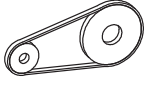
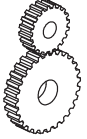
		ÇIKIŞ DEVRİ N2 (rpm)	GÜÇ HP			ÇIKIŞ DEVRİ N2 (rpm)	GÜÇ HP
i	RATIO : i			i	RATIO : i		
1:1	10	90	50	1:1	10	140	60
	15	60	40		15	93	50
	20	45	30		20	70	40
	25	36	25		25	56	30
	30	30	20		30	47	25
1:1,5	10	60	40	1:1,5	10	93	40
	15	40	30		15	62	40
	20	30	20		20	47	30
	25	24	20		25	37	20
	30	20	15		30	31	20
1:2	10	45	25	1:2	10	70	30
	15	30	20		15	47	25
	20	23	15		20	35	20
	25	18	15		25	28	15
	30	15	10		30	24	15
1:2,5	10	36	20	1:2,5	10	56	25
	15	24	20		15	37	20
	20	18	15		20	28	20
	25	14	10		25	22	15
	30	12	10		30	19	10
1:3	10	30	15	1:3	10	47	20
	15	20	10		15	31	20
	20	15	10		20	23	15
	25	12	10		25	19	10
	30	10	7,5		30	16	10

REDÜKTÖR GÜÇ ve SEÇİM TABLOSU
CHARACTERISTICS of RDX SERIES GEARBOX

AĞIRLIK
125
KG

$n_1 = 900 \text{ rpm}$

RDX 7

$n_1 = 1400 \text{ rpm}$

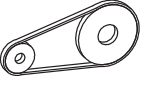
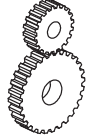
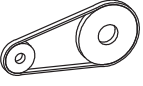
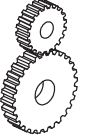
		ÇIKIŞ DEVRİ N2 (rpm)	GÜÇ HP			ÇIKIŞ DEVRİ N2 (rpm)	GÜÇ HP
i	RATIO : i			i	RATIO : i		
1:1	10	90	60	1:1	10	140	75
	15	60	50		15	93	60
	20	45	40		20	70	50
	25	36	30		25	56	40
	30	30	25		30	47	30
1:1,5	10	60	40	1:1,5	10	93	50
	15	40	40		15	62	40
	20	30	30		20	47	40
	25	24	20		25	37	30
	30	20	20		30	31	20
1:2	10	45	30	1:2	10	70	40
	15	30	25		15	47	30
	20	23	20		20	35	25
	25	18	15		25	28	20
	30	15	15		30	24	15
1:2,5	10	36	25	1:2,5	10	56	30
	15	24	20		15	37	25
	20	18	20		20	28	20
	25	14	15		25	22	20
	30	12	10		30	19	15
1:3	10	30	20	1:3	10	47	25
	15	20	20		15	31	20
	20	15	15		20	23	20
	25	12	10		25	19	15
	30	10	10		30	16	10

REDÜKTÖR GÜÇ ve SEÇİM TABLOSU
CHARACTERISTICS of RDX SERIES GEARBOX

AĞIRLIK
160
KG

$n_1 = 900 \text{ rpm}$

RDX 8

$n_1 = 1400 \text{ rpm}$

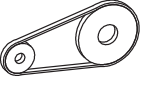
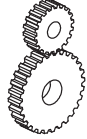
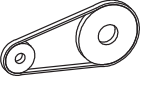
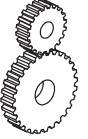
		ÇIKIŞ DEVRİ N2 (rpm)	GÜÇ HP			ÇIKIŞ DEVRİ N2 (rpm)	GÜÇ HP
i	RATIO : i			i	RATIO : i		
1:1	10	90	75	1:1	10	140	100
	15	60	60		15	93	75
	20	45	50		20	70	60
	25	36	50		25	56	50
	30	30	40		30	47	40
1:1,5	10	60	50	1:1,5	10	93	75
	15	40	40		15	62	50
	20	30	40		20	47	40
	25	24	30		25	37	40
	30	20	30		30	31	30
1:2	10	45	40	1:2	10	70	50
	15	30	30		15	47	40
	20	23	25		20	35	30
	25	18	25		25	28	25
	30	15	20		30	24	20
1:2,5	10	36	30	1:2,5	10	56	40
	15	24	25		15	37	30
	20	18	20		20	28	25
	25	14	20		25	22	20
	30	12	15		30	19	20
1:3	10	30	25	1:3	10	47	40
	15	20	20		15	31	25
	20	15	20		20	23	20
	25	12	20		25	19	20
	30	10	15		30	16	15

RDX GÖVDE ÖLÇÜLERİ

OVERALL DIMENSIONS

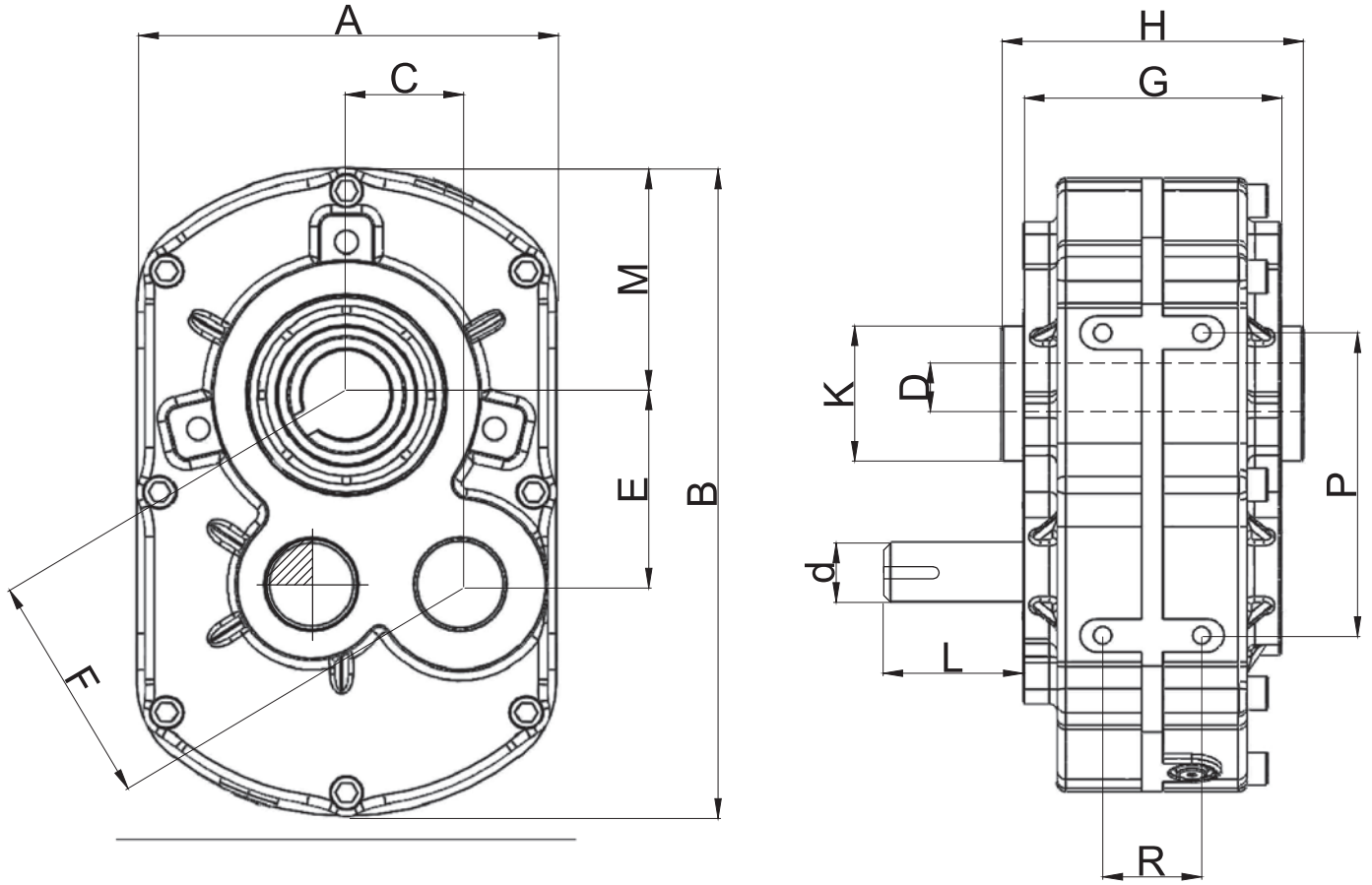

	A	B	C	M	E	F	G	H	K	L	d	P	R	D
RDX 1	180	253	49	96	81	94,66	114	134	55	60	19	80	52	30
RDX 2	210	289	55	105	96	110,64	116	136	65	75	28	95	68	40
RDX 3	242	330	62	124	108	124,53	150	170	75	90	32	123	93	50
RDX 4	265	385	70	140	122	140,65	159	189	85	100	40	138	100	60
RDX 5	334	480	77	178	144	149,18	168	198	95	110	48	150	116	70
RDX 6	385	542	104	192	171	200,14	178	208	120	120	55	190	148	80
RDX 7	477	660	130	239	211	247,83	200	240	140	130	60	240	200	95
RDX 8	515	718	153	257	241	285,46	356	396	155	140	65	300	250	105

ÇIKIŞ MİLİ ÖLÇÜLERİ

OVERALL DIMENSIONS

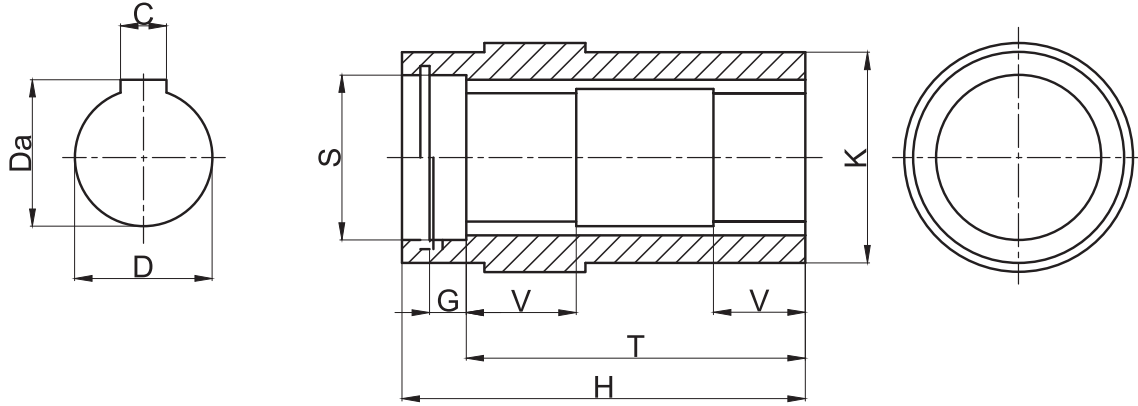

	D	C	Da	G	K	H	S	T	V
RDX 1	25	8	28	10	55	134			
RDX 1	30	10	33,4	10	55	134			
RDX 1	35	10	38,4	10	55	134			
RDX 2	40	12	43,4	12	65	136	40	110	40
RDX 2	45	14	48,6	12	65	136	50	129	30
RDX 3	45	14	48,6	12	75	170	50	129	30
RDX 3	50	14	53,6	14	75	170	60	142.5	35
RDX 3	55	16	58,9	14	75	170	60	142.5	35
RDX 4	55	16	58,9	14	85	189	65	142.5	35
RDX 4	60	18	64,3	14	85	189	60	175	50
RDX 4	65	18	69,3	14	85	189	65	175	50
RDX 5	65	18	69,3	14	95	198	70	175	50
RDX 5	70	20	74,7	16	95	198	70	185.5	60
RDX 5	75	20	79,7	16	95	198	85	185.5	60
RDX 6	75	20	79,7	16	120	208	85	208	50
RDX 6	80	20 *	84,7	16	120	208	100	208	50
RDX 6	85	20 *	89,7	16	120	208	95	226.5	55
RDX 7	90	25	95,6	20	140	240	120	226.5	55
RDX 7	95	25	100,6	20	140	240	120	302	60
RDX 7	100	28	106,2	20	140	240	145	302	60
RDX 8	100	28	106,2	22	155	406	145	302	60
RDX 8	105	28	111,2	22	155	406	145	302	60
RDX 8	110	28	116,2	22	155	406	145	302	60

RDX TİPİ REDÜKTÖR GERDİRME APARATI ÖLÇÜLERİ

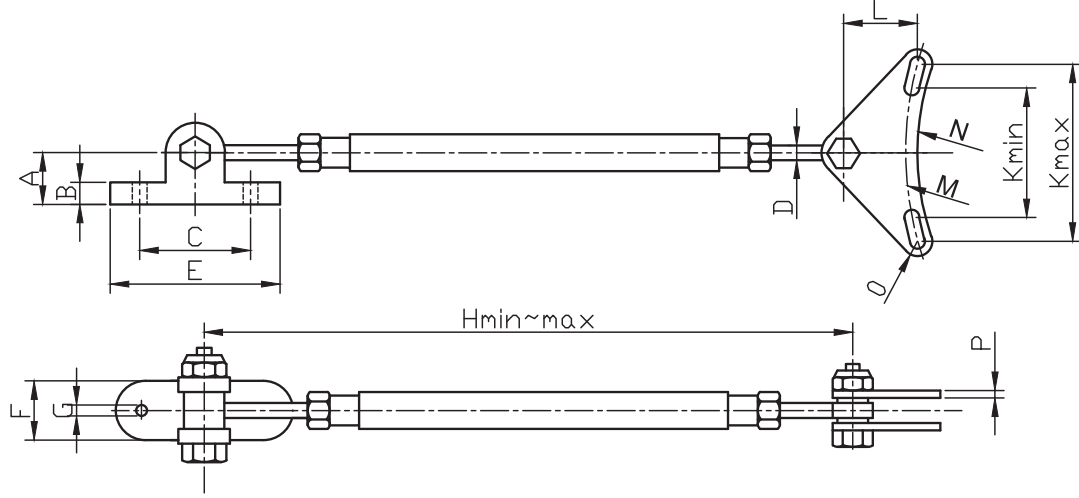

	A	B	C	D	E	F	G	Hmin.	Hmax.	Kmin.	Kmax.	L	M	N	O	P
RDX 1	25	10	50	M10	75	25	8.5	200	300	60	92	51	117	110	20	6
RDX 2	35	16	70	M12	105	35	10.5	210	310	73	115	66	218	110	22	6
RDX 3	35	16	70	M12	105	35	10.5	210	310	103	132	67	244	239	25	6
RDX 4	40	18	75	M14	115	40	12.5	240	360	157	157	70	200	190	10.5	6
RDX 5	40	18	75	M14	115	40	12.5	240	360	179	179	84	230	218	12.5	8
RDX 6	45	20	85	M16	135	50	14.5	260	410	199	199	100	260	247	12.5	10
RDX 7	45	20	85	M16	135	50	14.5	260	410	218	218	102	285	272	13	10
RDX 8	65	30	150	M20	220	70	25	340	560	263	263	100	335	315	17	14

BAĞLANTI ŞEKLİ

ARM ADJUSTMENT

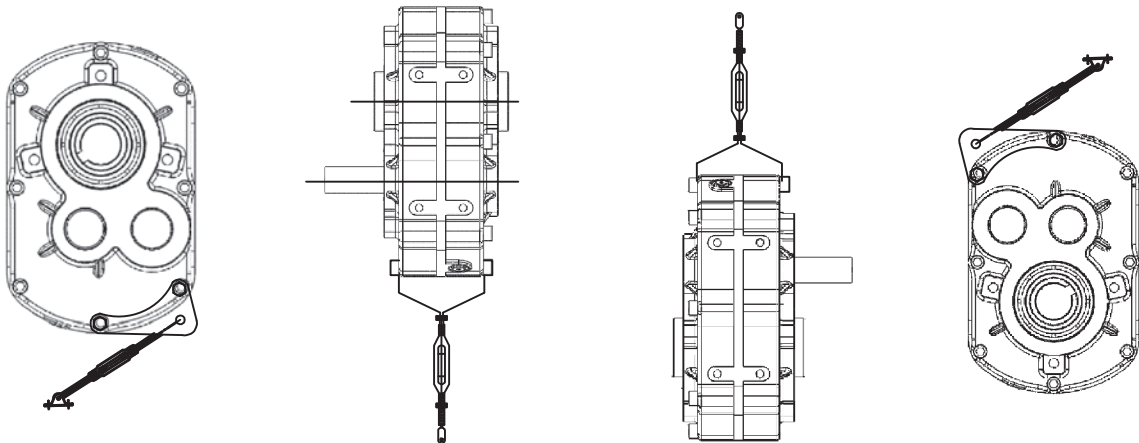



REMAK Redüktör

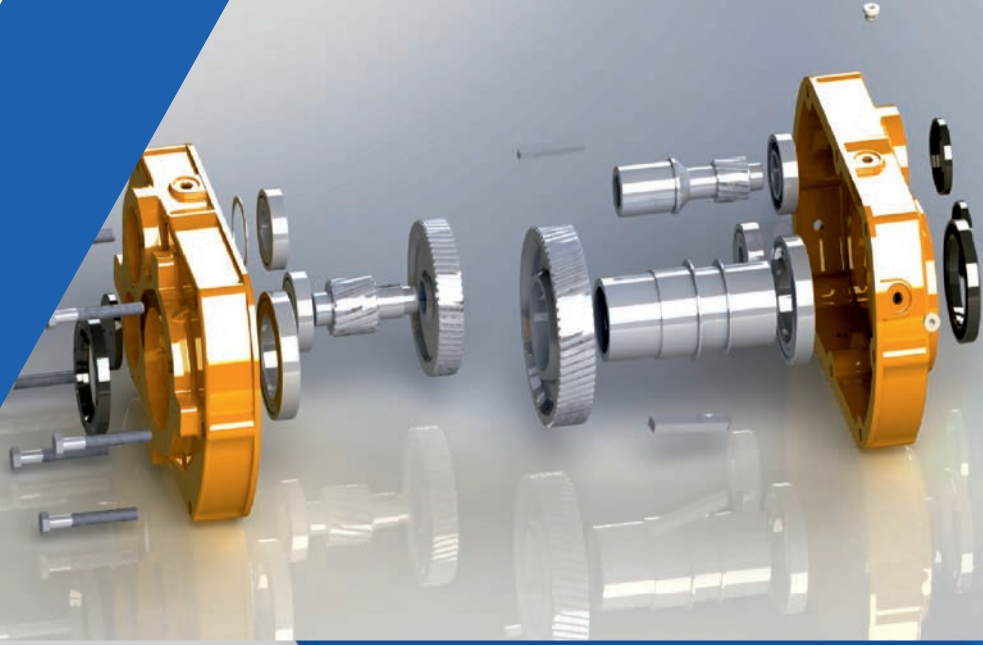

Kemalpaşa Organize Sanayi Bölgesi Kuyucak Yolu Caddesi
No:211 Kemalpaşa / İzmir



0(232) 479 68 18 - 19



remakreduktor.com.tr



info@remakreduktor.com.tr